

Bestar Electronics Industry Co., Ltd.

Omni-Directional Back Electret Condenser Microphone Noise Cancelling Electret Condenser Microphone Unidirectional Electret Condenser Microphone Omni-Directional Electret Condenser Microphone Omni-Directional Back Electret Condenser Microphone Noise Cancelling Electret Condenser Microphone Unidirectional Electret Condenser Microphone Omni-Directional Condenser Microphone Omni-Directional Condenser Microphone Noise Cancelling Electret Condenser Microphone Unidirectional Electret Condenser Microphone Omni-Directional Electret Condenser Microphone Omni-Directional Back Electret Condenser Microphone Noise Cancelling Electret Condenser Microphone Unidirectional Electret Condenser Microphone Omni-Directional Electret Condenser Microphone Omni-Directional Back Electret Condenser Microphone Noise Cancelling Electret Condenser Microphone Unidirectional Electret Condenser Microphone Omni-Directional Electret Condenser Microphone

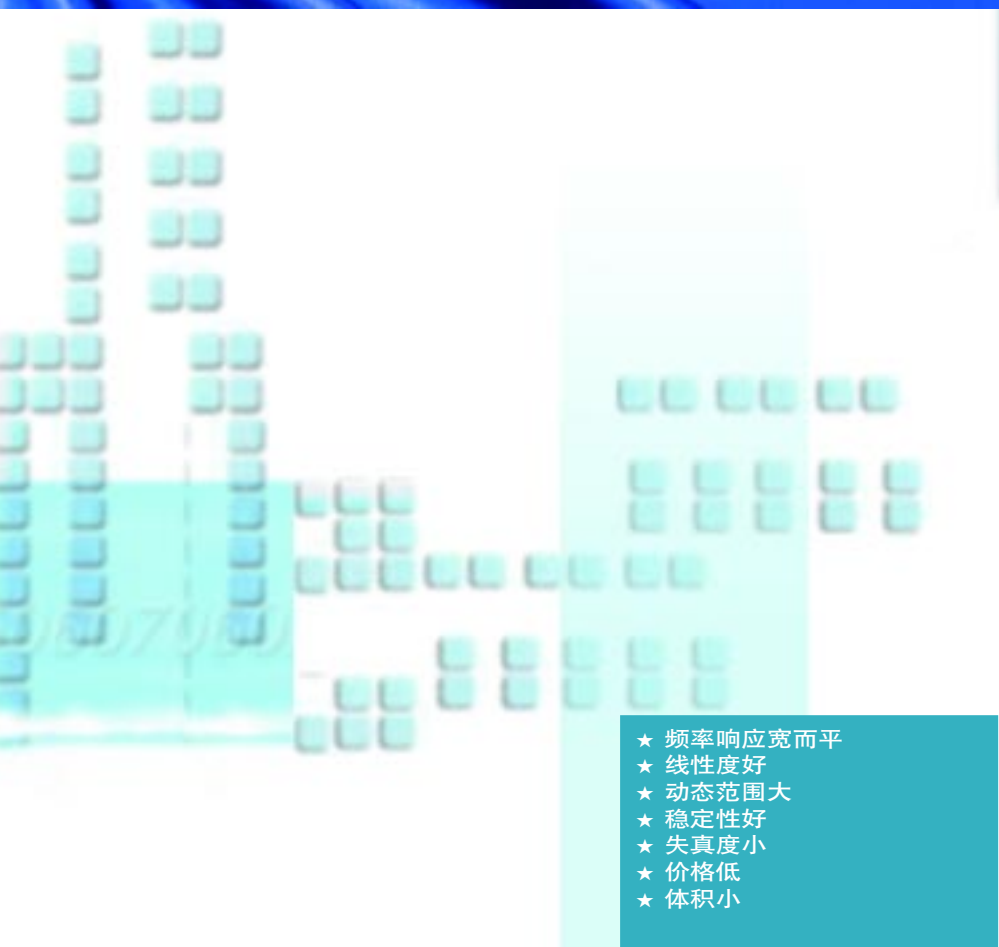

Aesthetic design
Built in quality



- ★ 频率响应宽而平
- ★ 线性度好
- ★ 动态范围大
- ★ 稳定性好
- ★ 失真度小
- ★ 价格低
- ★ 体积小

Omni-Directional Back Electret Condenser Microphone

BCM6018, BCM6018S, BCM6018P

Very small, omnidirectional microphone
Most suited to products having limited space

Specifications:

- | | |
|--|--------------------------------------|
| 1. Sensitivity: see below | 2. Impedance: low impedance |
| 3. Directivity: omnidirectional | 4. Frequency: 100 - 20,000Hz |
| 5. Max. operation voltage: 10V | 6. Current consumption: 0.4mA (max.) |
| 7. Sensitivity reduction: within -3dB (Vs:2.0V → 1.5V) | |
| 8. S/N ratio: more than 58dB | |

Notes:

- Test Condition Vs=2V, RL=2.2Kohm
Sensitivity (1KHz): 0dB=1v/Pa, -42 ± 3, 44 ± 3, -46 ± 3
- Inside capacitor is available according to clients' requests

Frequency Resonse Curve

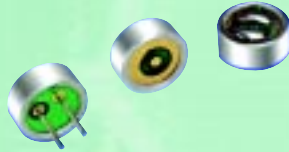
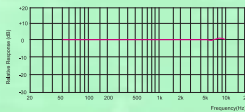

Drawing

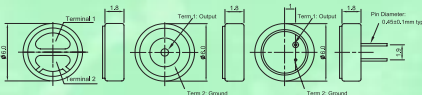

Noise Cancelling Electret Condenser Microphone

BCM6027N BCM6027PN

Very Small noise cancelling microphone
Close talk characteristics effectively reduce ambient noise

Specifications:

- | | |
|------------------------------------|---|
| 1. Sensitivity: see below | 2. Impedance: Less than 2.2k ohm |
| 3. Directivity: Noise cancelling | 4. Frequency: 100 - 10,000Hz |
| 5. Max. operation voltage: 10V | 6. Standard operation voltage: 2V |
| 7. Current consumption: Max. 0.5mA | 8. Sensitivity reduction: within -3dB at 1.5V |
| 9. S/N ratio: More than 50dB | |

Notes:

- Test Condition Vs=2V, RL=2.2Kohm
Sensitivity (1KHz): 0dB=1v/Pa, -46 ± 3, -48 ± 3, -50 ± 3

Frequency Resonse Curve

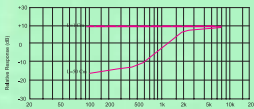

Drawing

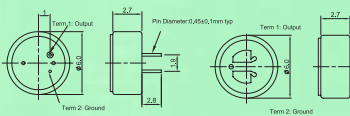

Noise Cancelling Electret Condenser Microphone

BCM9745N

Small noise cancelling microphone
Close talk characteristics effectively reduce ambient noise

Specifications:

- | | |
|--|--|
| 1. Sensitivity: See below | 2. Impedance: Less than 2.2kohm |
| 3. Directional: Noise cancelling | 4. S/N Ratio: More than 40dB(0dB=1V/Pa, 1kHz) |
| 5. Max. Input Sound Level: 100dB S.P.L | 6. Frequency Response: 20Hz-10kHz |
| 7. Rate Voltage: 2.5V | 8. Decreasing Voltage characteristic: -3dB (Vs=1.5V) |

Notes:

- Test Condition Vs=2.5V, RL=2.2Kohm
Sensitivity (1KHz): 0dB=1v/Pa, 1kHz 45 ± 5dB

Frequency Resonse Curve

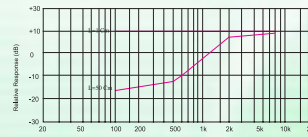

Drawing

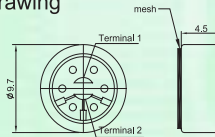

Omni-Directional Back Electret Condenser Microphone

BCM6027 BCM6027S BCM6027P

Very small, omnidirectional microphone
Most suited to products having limited space
back electret type designed for high resistance to vibrations

Specifications:

- | | |
|--|--------------------------------------|
| 1. Sensitivity: see below | 2. Impedance: low impedance |
| 3. Directivity: omnidirectional | 4. Frequency: 20 - 16,000Hz |
| 5. Max. operation voltage: 10V | 6. Current consumption: 0.4mA (max.) |
| 7. Sensitivity reduction: within -3dB (Vs:2.0V → 1.5V) | |
| 8. S/N ratio: more than 58dB | |

Notes:

- Test Condition Vs=2V, RL=2.2Kohm
Sensitivity (1KHz): 0dB=1v/Pa, -34 ± 3, -36 ± 3, -38 ± 3, -40 ± 3, -42 ± 3, 44 ± 3
Test Condition Vs=1.5V, RL=2.2Kohm
Sensitivity (1KHz): 0dB=1v/Pa, -34 ± 3, -36 ± 3, -38 ± 3, -40 ± 3
- built-in capacitor is available according to clients' requests

Frequency Resonse Curve

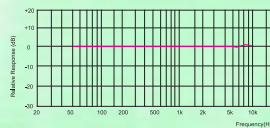

Drawing

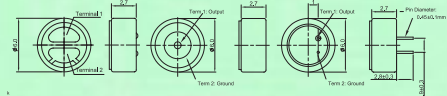

Noise Cancelling Electret Condenser Microphone

BCM9750N

Small noise cancelling microphone
Close talk characteristics effectively reduce ambient noise



Frequency Resonse Curve

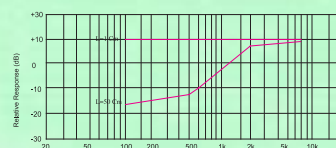

Drawing

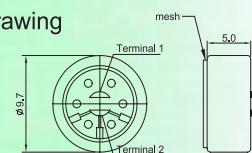

Specifications:

- | | |
|--|---|
| 1. Sensitivity: see below | 2. Impedance: Less than 680ohm |
| 3. Directional: Noise cancelling | 4. S/N Ratio: more than 40dB(0dB=1V/Pa, 1kHz) |
| 5. Max. Input Sound Level: 100dB S.P.L | 6. Frequency Response: 100Hz-10kHz |
| 7. Rate Voltage: 1.5V | 8. Decreasing Voltage characteristic: -3dB (at 1 V) |

Notes:

- Test Condition Vs=1.5V, RL=680ohm
Sensitivity (1KHz): 0dB=1v/Pa, 1kHz 54 ± 4dB

Unidirectional Electret Condenser Microphone

BCM9750U

Unidirectional microphone for general use

Specifications

1. Sensitivity: See below
2. Impedance: Less than 680ohm
3. Directional: Unidirectional
4. S/N Ratio: More than 58dB(0dB=1V/Pa,1kHz)
5. Max. Input Sound Level: 100dB S.P.L
6. Frequency Response: 100Hz-10kHz
7. Rate Voltage: 1.5V
8. Decreasing Voltage characteristic: -3dB(at 1V)

Notes:

1. Test Condition $V_s=1.5V$, $R_L=680ohm$
Sensitivity (1KHz): $-47 \pm 4dB$, $-50 \pm 4(0dB=1V/Pa,1kHz)$

Frequency Resonse Curve

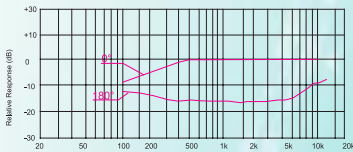

Drawing

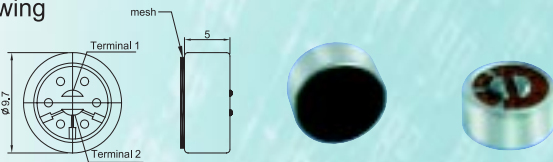

Omni-Directional Electret Condenser Microphone

BCM9745PC

Highest performance, electret condenser microphone cartridge.
useful for almost any type of telephone and other applications

Specifications

1. Sensitivity: See below
2. Impedance: Less than 2Kohm
3. Directional: Omnidirectional
4. S/N Ratio: more than 60dB(0dB=1V/Pa,1kHz)
5. Max. Input Sound Level: 100dB S.P.L
6. Frequency Response: 20Hz-16kHz
7. Rate Voltage: 1.5V
8. Operating Voltage: 1.5-10V
9. Capacitor: 10pF
10. Decreasing Voltage characteristic: -3dB(at 1V)

Notes:

1. Test Condition $V_s=1.5V$, $R_L=2kohm$
Sensitivity (1KHz): $-38 \pm 2dB$, $-40 \pm 2(0dB=1V/Pa,1kHz)$

Frequency Resonse Curve

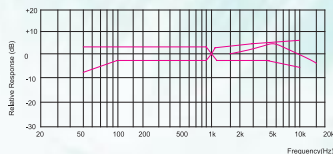

Drawing

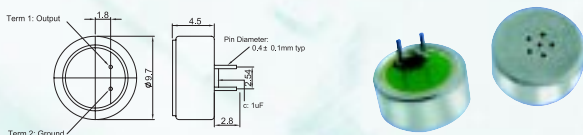

Omni-Directional Electret Condenser Microphone

BCM9745 BCM-9745P

useful for almost any type of telephone and other applications

Specifications:

1. Sensitivity: see below
2. Impedance: 2.2Kohm
3. Directivity: omnidirectional
4. Frequency: 100 - 16,000Hz
5. Max. operation voltage: 10V
6. Current consumption: 0.6mA (max.)
7. Sensitivity reduction: within -3dB ($V_s:2.0V \rightarrow 1.5V$)
8. S/N ratio: more than 60dB

Notes:

1. Test Condition $V_s=2.5V$, $R_L=2.2Kohm$
Sensitivity (1KHz): $0dB=1V/Pa$, -38 ± 3 , -40 ± 3 , -42 ± 3 , -44 ± 3
built-in capacitor is available according to clients' requests

Frequency Resonse Curve

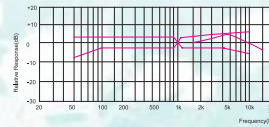

Drawing

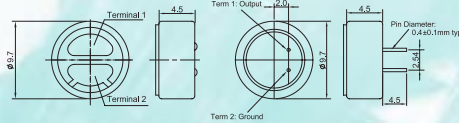

Omni-Directional Electret Condenser Microphone

BCM9765 BCM9765P

Useful for tape recorders, toys, telephones, and almost any other applications

1. Sensitivity: see below
2. Impedance: 2.2kohm
3. Directivity: omnidirectional
4. Frequency: 20 - 16,000Hz
5. Max. operation voltage: 10V
6. Current consumption: 0.5mA (max.)
7. Sensitivity reduction: within -3dB ($V_s:4.5V \rightarrow 1.5V$)
8. S/N ratio: more than 60dB

Notes:

1. Test Condition $V_s=4.5V$, $R_L=2.2K\Omega$
Sensitivity: $0dB=1V/Pa,1kHz$, -44 ± 2 , -42 ± 2 , -40 ± 2 , -38 ± 2 , -36 ± 2 , -34 ± 2 , -32 ± 2

Frequency Resonse Curve

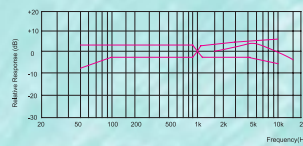

Drawing

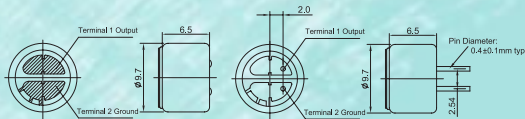

Omni-Directional Electret Condenser Microphone

BCM9767 BCM9767P

Useful for tape recorders, toys, telephones, and almost any other applications

Specifications:

1. Sensitivity: see below
2. Impedance: Less than 2.2kohm
3. Directivity: omnidirectional
4. Frequency: 20 - 16,000Hz
5. Max. operation voltage: 10V
6. Current consumption: 0.5mA (max.)
7. Sensitivity reduction: within -3dB ($V_s:1.5V$)
8. S/N ratio: more than 60dB

Notes:

1. Test Condition $V_s=3.0V$, $R_L=2.2K\Omega$
Sensitivity (1KHz): $0dB=1V/Pa$, -44 ± 2 , -42 ± 2 , -40 ± 2 , -38 ± 2 , -36 ± 2
2. Test Condition $V_s=1.5V$, $R_L=2Kohm$
Sensitivity(1KHz): $0dB=1V/Pa$, -36 ± 2 , -38 ± 2 , -40 ± 2

Frequency Resonse Curve

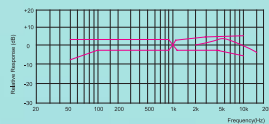

Drawing

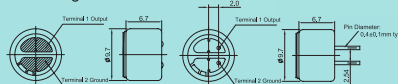

Omni-Directional Condenser Microphone

BCM4015L

Specifications:

- 1.Sensitivity: see below
- 2.Impedance: Less than 2.2Kohm
- 3.Directivity: Omnidirectional
- 4.Frequency:20-20,000Hz
- 5.Max. Operation voltage:10V
- 6.Current consumption:0.5mA(max)
- 7.Sensitivity reduction: within-3dB(Vs:1.5V)8.S/N Ratio: more than 58dB

Notes:

- 1.Test Condition Vs=2.0V ,RL=2.2KΩ
- Sensitivity (1KHz): 0dB=1v/Pa, -44 ± 3,-42 ± 3,-40 ± 3

★Frequency Resonse Curve

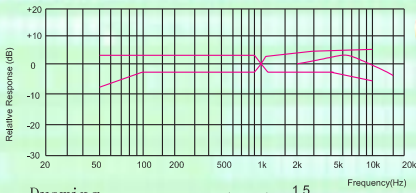

Drawing

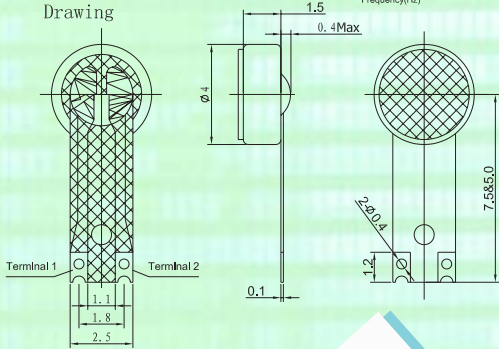

Measurement Circuit:

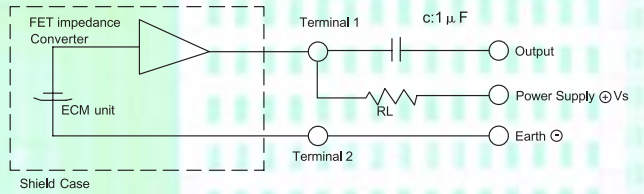

Built-in Capacitor Measurement Circuit:

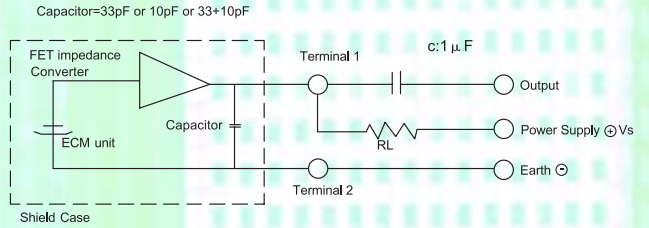

常州市声易通电子有限公司

江苏省高新技术企业

地址: 中国常州新区天安工业村
 内销电话: 86-519-5120206 传真: 86-519-5131010
 外销电话: 86-519-5101830 传真: 86-519-5112871
 邮编: 213022
 E-mail: wu@be-star.com
 bestarco@pub.cz.jsinfo.net
 http://www.be-star.com
 //www.be-star.cn

BESTAR ELECTRONICS INDUSTRY CO.,LTD.

Add: Tian-an Industry Park,High-new-tech Development
 District Changzhou,P.R.China
 Domestic Tel: 86-519-5120206 Fax: 86-519-5131010
 Oversea Tel: 86-519-5101830 Fax: 86-519-5112871
 P.C: 213022
 E-mail: wu@be-star.com
 bestarco@pub.cz.jsinfo.net
 http://www.be-star.com
 //www.be-star.cn