



BeStar Technologies Inc.
Address: 761 N. 17th Street Unit 4, St. Charles, IL 60174
Tel : 847-261-2850 E-mail : sales@bestartech.com Web : www.bestartech.com

Document Number : 1808-31
Revision : A1
Total Pages : 6
Prepare by : Loki, Lo
Date : 17 August, 2018

SENER Brand Power Product

www.jlsener.com

Document Type : Specification
Product Type : Lithium/Manganese Dioxide (LiMnO₂) Coin Cell
Ordering Code : SCR2320
Cell Part Number : CR2320
Cell UL Number : MH20926

A1 - New issue created by Loki, Lo on 17 Aug., 2018		

This material is the property of BeStar Technologies Inc.
Unauthorized copying or use of this material is prohibited.

1. Purpose and Scope

This document contains both general requirements, qualification requirements, and those specific electrical, mechanical requirements for this part.

2. Description

Ø23mm Lithium/Manganese Dioxide (LiMnO₂) coin cell, RoHS compliant.

3. Application

Computers and Peripherals, Portable Equipment, DECT phone, etc.

4. Component Requirement

4.1. General Requirement

4.1.1. Operating Temperature Range : -20°C to +70°C

4.1.2. Storage Temperature Range : 0°C to +30°C

4.1.3. Storage Humidity : 35 ~ 75%

4.1.4. Weight : Approx. 3g

4.1.5. Materials of Positive Terminal : SUS stainless

4.1.6. Materials of Negative Terminal : SUS stainless

4.2. Electrical Requirement

4.2.1. Nominal Voltage : 3V

4.2.2. Nominal Capacity : 130mAh
(under Load 15kΩ Load and 2.0V End-voltage)

4.2.3. Load Resistance : 15KΩ

4.2.4. Standard Discharge Current : 0.2mA

4.3. Standard Characteristics

4.3.1. Discharge Characteristics

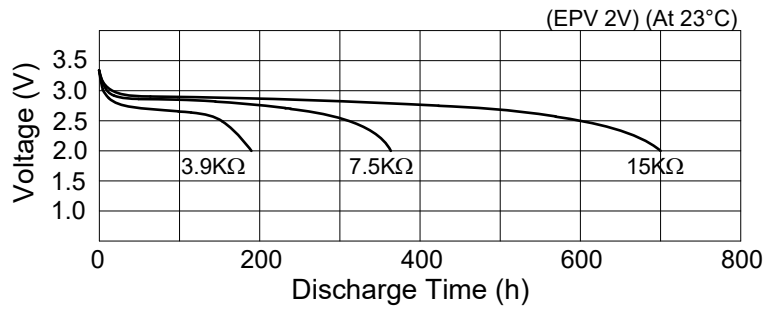

Figure 1. Discharge Characteristics

4.3.2. Load-Operating voltage

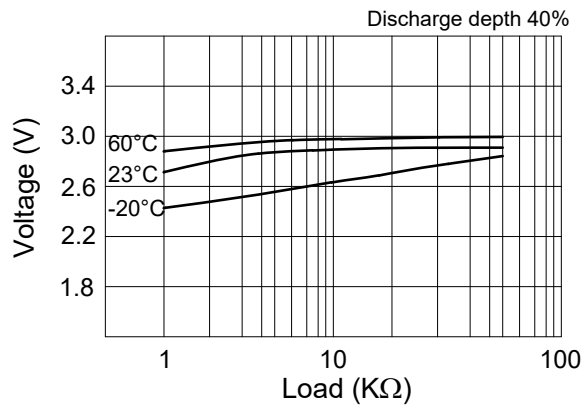

Figure 2. Load-Operating voltage

4.3.3. Pulse Discharge Characteristics

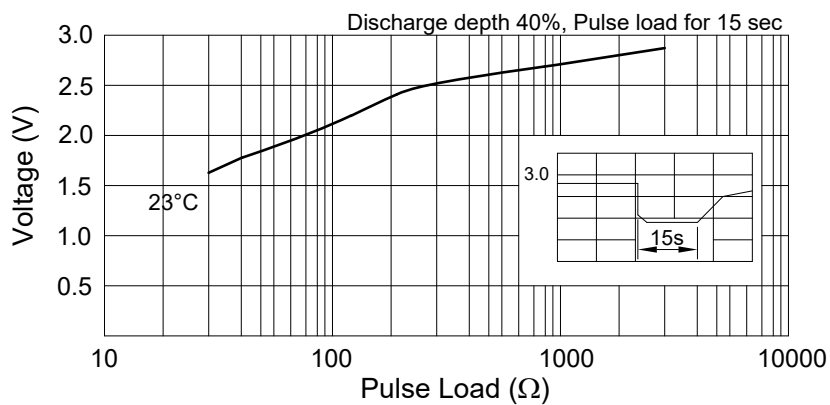

Figure 3. Pules Discharge Characteristics

4.3.4. Temperature Characteristics

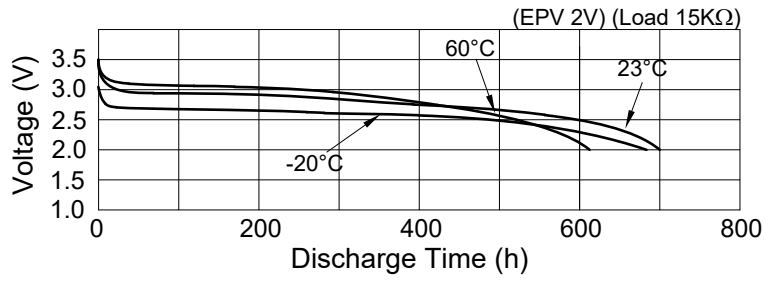

Figure 4. Temperature Characteristics

4.3.5. Load-Capacity

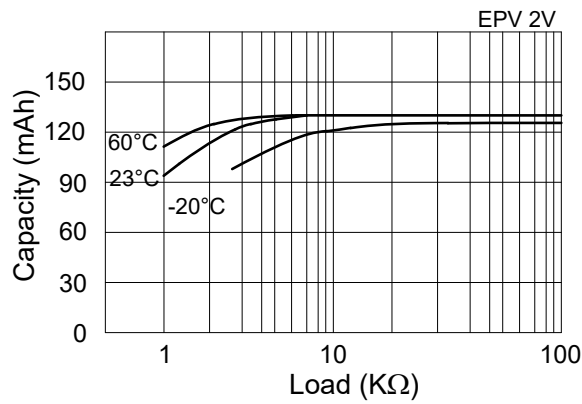

Figure 5. Load-Capacity

4.3.6. Storage Characteristics

(Storage at 60°C for 30 days equivalent to storage at room temperature for 18 months)

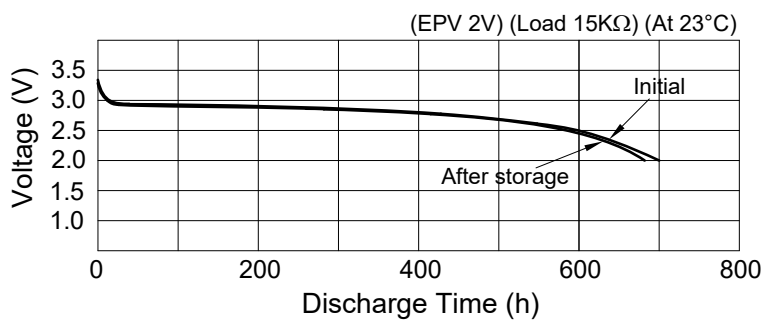

Figure 6. Storage Characteristics

5. Reliability Test

- 5.1. Open-circuit Voltage** : Subject samples to $+20 \pm 2$ °C and 0 ± 2 °C for 8 hours or longer. Then measure the voltage between both terminals at the same ambient temperature with voltmeter.
- 5.2. Short-circuit Voltage** : Subject samples to $+20 \pm 2$ °C and 0 ± 2 °C for 8 hours or longer. Then measure the voltage between both terminals with voltmeter while the 15K Ω is connected between both terminals at the same ambient temperature. Measured value shall be based on meter reading taken 8 seconds after the circuit is closed.
- 5.3. Service Life** : Subject samples to 20 ± 2 °C and 0 ± 2 °C for 8 hours or longer. Then continuously discharge at the same ambient temperature and through 15k Ω . Discharge until terminal voltage of the test specimens falls below the discharge end-point voltage of 2.0V, and the time during which the terminal voltage is equal to and above the discharge end-point voltage shall be taken as the service life.
- 5.4. Service Life after high temperature storage** : Store samples at $+60 \pm 2$ °C for 20 days. Then subject samples to $+20 \pm 2$ °C and ordinary humidity $65\% \pm 20\%$ for 12 hours or longer and continuously discharge through 15K Ω . Discharge until the voltage falls below the discharge end-point voltage of 2.0V, and the time during which the voltage is equal to and above the discharge end-point voltage shall be taken as the service life.
- 5.5. Electrolyte Leakage Test** : Samples shall be examined for electrolyte leakage while they are kept at $+20 \pm 2$ °C and ordinary humidity $75\% \pm 5\%$ after being stored at 45 ± 2 °C and 75% relative humidity for 30 days.
- 5.6. Self-discharge** : Store samples for 12 months at $+20 \pm 2$ °C and $65\% \pm 5\%$ relative humidity and tested for service life in accordance with the method specified in 5.3. Self-discharge shall be determined as follows:

$$\text{Self-discharge rate (\%)} = (Y1-Y2)/Y1 \times 100\%$$

Y1 : Average initial discharge life of batteries of the same lot

Y2 : Average discharge life after storage

6. Mechanical Layout

Unit : mm

Tolerance : Linear XX.X = ±0.3
 XX.XX = ±0.05
 Angular = ±0.25°

(unless otherwise specified)

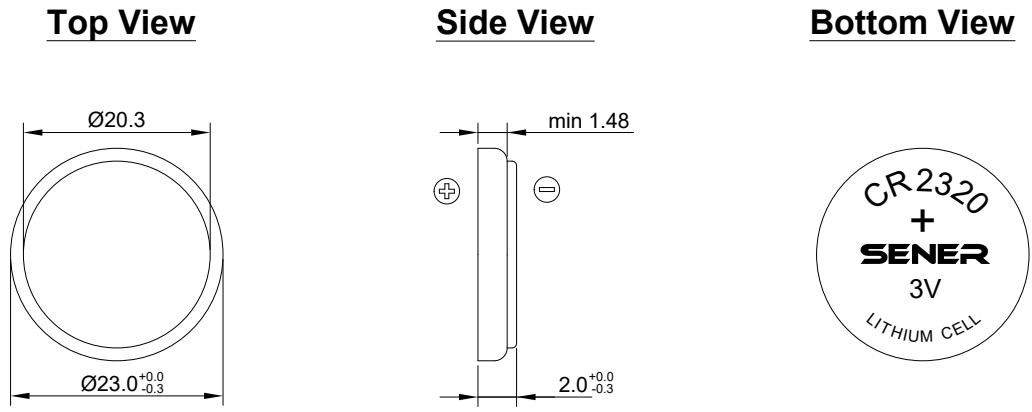

Figure 7. SCR2320 Mechanical Layout