



JL World Corporation Limited

Tel : (+852) 25650319 Fax : (+852) 25656979 Web : www.jlworld.com

Document Number : 0907-28
 Revision : A2
 Total Pages : 6
 Prepare by : Holmes, Poon
 Date : 16 November, 2011

SENER Power Product

Document Type : Specification
 Product Type : Lithium/Manganese Dioxide (LiMnO₂) Coin Cell
 Ordering Code : SCR3032
 Part Number : CR3032
 UL Number : MH20926

A1 - New issue created by Holmes, Poon on 24 Jul., 2009		
A2 - update section 4 & 6 by Holmes, Poon on 16 Nov., 2011		

This material is the property of JL World Corporation Limited.
 Unauthorized copying or use of this material is prohibited.

1. Purpose and Scope

This document contains both general requirements, qualification requirements, and those specific electrical, mechanical requirements for this part.

2. Description

Ø30mm Lithium/Manganese Dioxide (LiMnO₂) coin cell, RoHS compliant.

3. Application

Computers and Peripherals, Portable Equipment, DECT phone, etc.

4. Component Requirement

4.1 General Requirement

4.1.1.	Operating Temperature Range	: -20°C to +70°C
4.1.2.	Storage Temperature Range	: 0°C to +30°C
4.1.3.	Storage Humidity	: 40 ~ 75%
4.1.4.	Weight	: 6.8g
4.1.5.	Materials of Positive Terminal	: SUS430+Ni-plated
4.1.6.	Materials of Negative Terminal	: SUS430+Ni-plated

4.2 Electrical Requirement

4.2.1.	Nominal Voltage	: 3V
4.2.2.	Nominal Capacity (under Load 7.5kΩ Load and 2.0V End-voltage)	: 500mAh
4.2.3.	Load Resistance	: 7.5KΩ
4.2.4.	Standard Discharge Current	: 0.2mA

4.3 Standard Characteristics

4.3.1. Discharge Characteristics

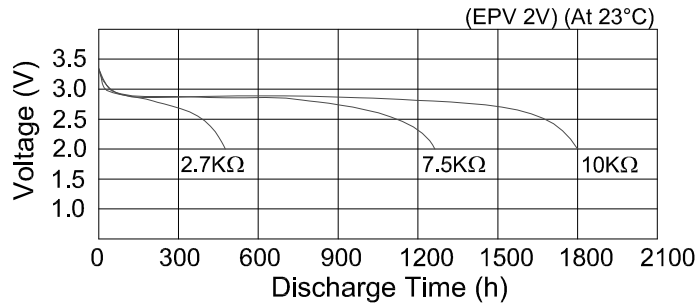

Figure 1. Discharge Characteristics

4.3.2. Load-Operating voltage

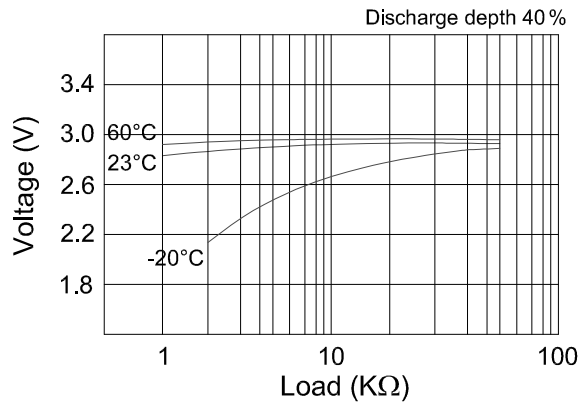

Figure 2. Load-Operating voltage

4.3.3. Pulse Discharge Characteristics

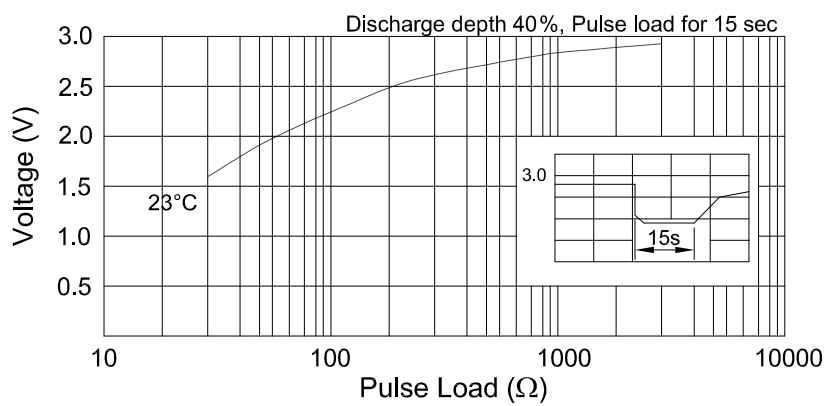

Figure 3. Pules Discharge Characteristics

4.3.4. Temperature Characteristics

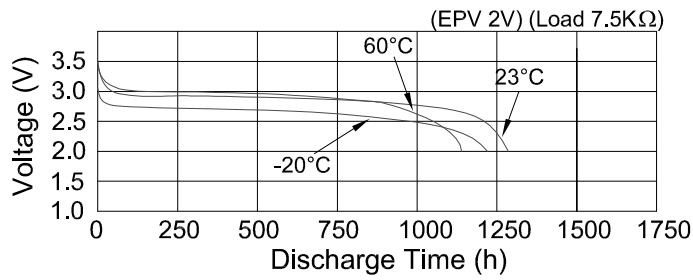

Figure 4. Temperature Characteristics

4.3.5. Load-Capacity

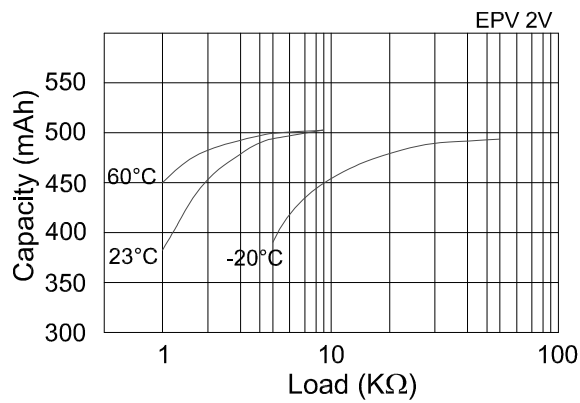

Figure 5. Load-Capacity

4.3.6. Storage Characteristics

(Storage at 60°C for 30 days equivalent to storage at room temperature for 18 months)

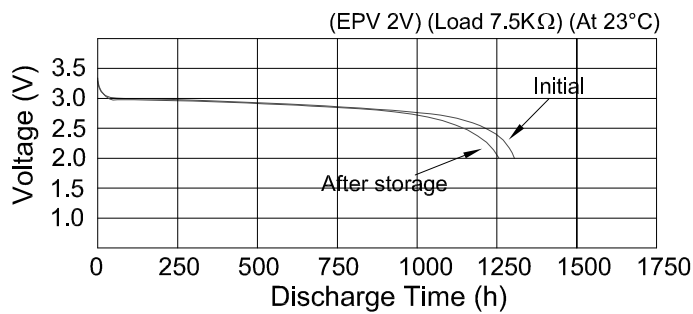

Figure 6. Storage Characteristics

5. Reliability Test

- 5.1. Open-circuit Voltage :** Subject samples to $+20 \pm 2$ °C and 0 ± 2 °C for 8 hours or longer. Then measure the voltage between both terminals at the same ambient temperature with voltmeter.
- 5.2. Short-circuit Voltage :** Subject samples to $+20 \pm 2$ °C and 0 ± 2 °C for 8 hours or longer. Then measure the voltage between both terminals with voltmeter while the 7.5K Ω is connected between both terminals at the same ambient temperature. Measured value shall be based on meter reading taken 8 seconds after the circuit is closed.
- 5.3. Service Life :** Subject samples to 20 ± 2 °C and 0 ± 2 °C for 8 hours or longer. Then continuously discharge at the same ambient temperature and through 7.5k Ω . Discharge until terminal voltage of the test specimens falls below the discharge end-point voltage of 2.0V, and the time during which the terminal voltage is equal to and above the discharge end-point voltage shall be taken as the service life.
- 5.4. Service Life after high temperature storage :** Store samples at $+60 \pm 2$ °C for 20 days. Then subject samples to $+20 \pm 2$ °C and ordinary humidity 65% \pm 20% for 12 hours or longer and continuously discharge through 7.5K Ω . Discharge until the voltage falls below the discharge end-point voltage of 2.0V, and the time during which the voltage is equal to and above the discharge end-point voltage shall be taken as the service life.
- 5.5. Electrolyte Leakage Test :** Samples shall be examined for electrolyte leakage while they are kept at $+20 \pm 2$ °C and ordinary humidity 75% \pm 5% after being stored at 45 ± 2 °C and 75% relative humidity for 30 days.
- 5.6. Self-discharge :** Store samples for 12 months at $+20 \pm 2$ °C and 65% \pm 5% relative humidity and tested for service life in accordance with the method specified in 5.3. Self-discharge shall be determined as follows:

$$\text{Self-discharge rate (\%)} = (Y1-Y2)/Y1 \times 100\%$$

Y1 : Average initial discharge life of batteries of the same lot

Y2 : Average discharge life after storage

6. Mechanical Layout

Unit : mm

Tolerance : Linear XX.X = ±0.3
 XX.XX = ±0.05
 Angular = ±0.25°
 (unless otherwise specified)

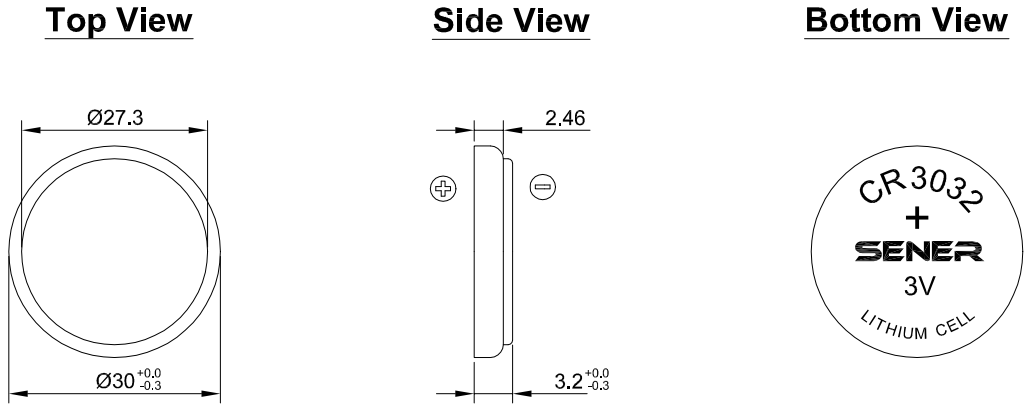

Figure 7. SCR3032 Mechanical Layout